

DRITHERM® CAVITY SLAB INSTALLATION GUIDE



WHAT YOU NEED TO KNOW



challenge.
create.
care.

TYPICAL CONSTRUCTION

BRICK OUTER WITH BLOCK INNER LEAF

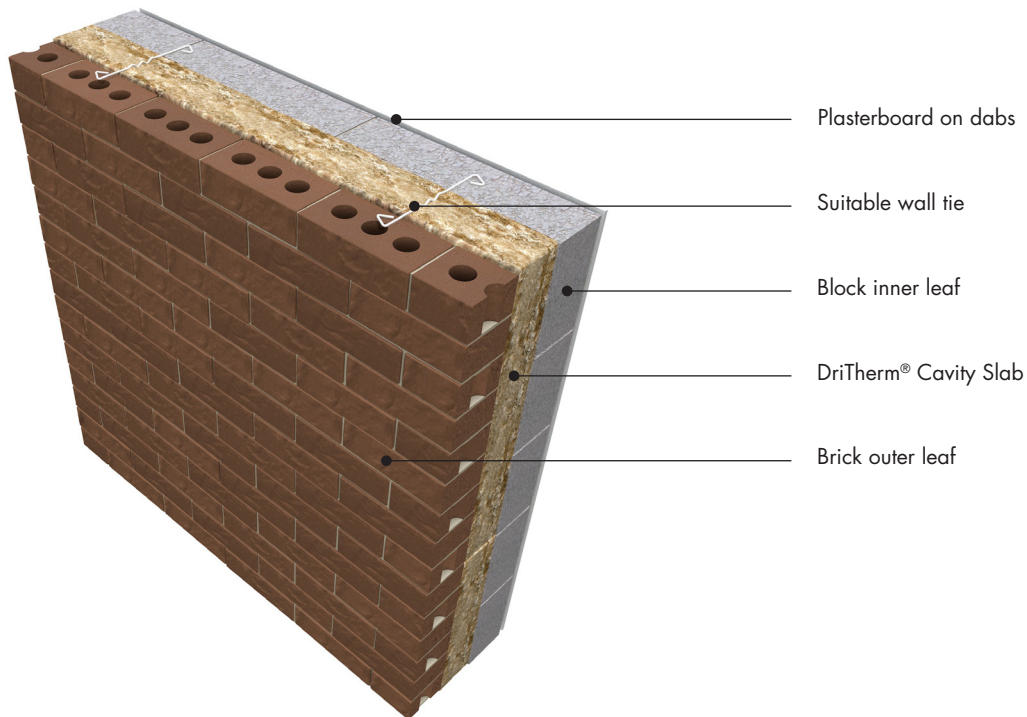

BLOCK OUTER WITH BLOCK INNER LEAF

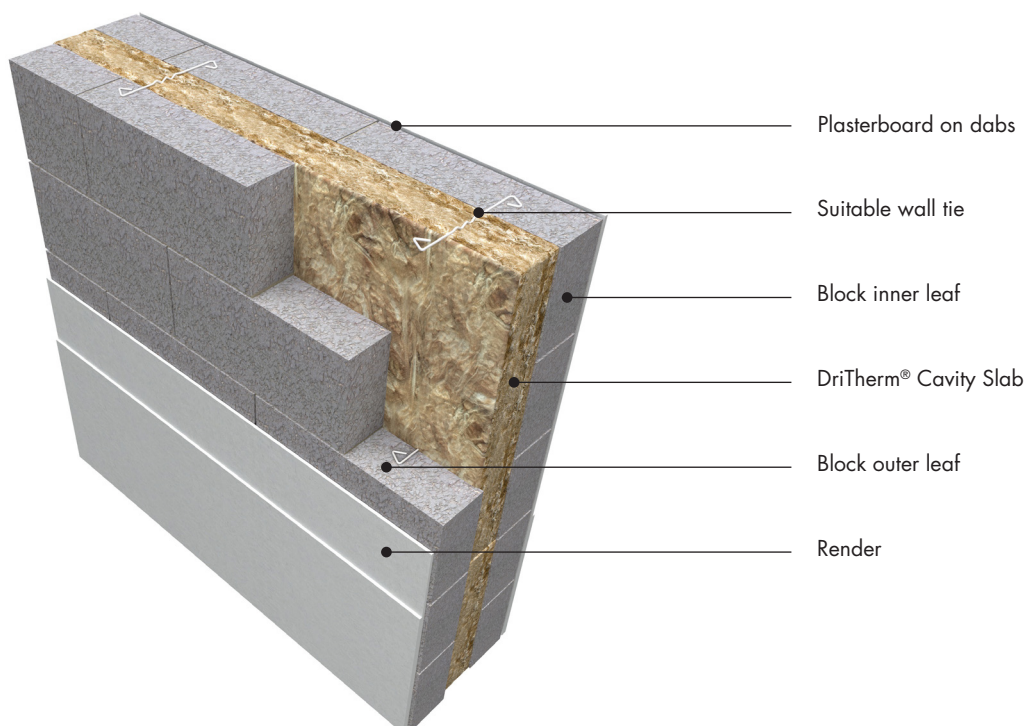

STORAGE

PRE-INSTALLATION STORAGE ON SITE

DriTherm® Cavity Slabs should be stored properly and handled in such a way as to ensure that they are clean and undamaged.

DriTherm® Cavity Slabs are supplied in polythene packs or shrink wrapped pallets which are designed for short term protection only. Packs should be kept under cover once the outer hood is split.

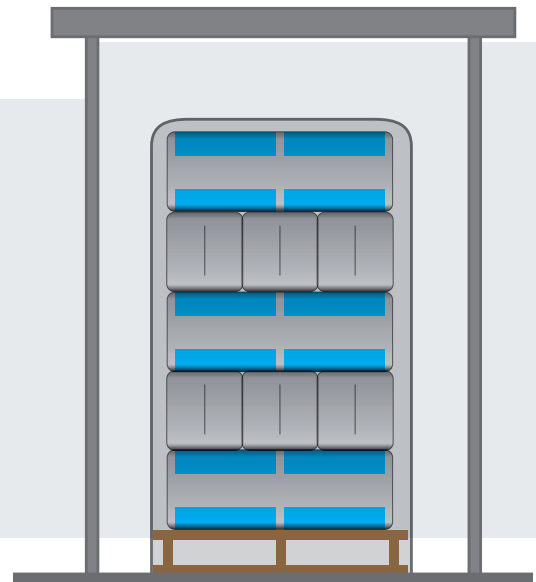

✓ Slabs protected from weathering potential

For longer term protection on site the product should either be stored indoors or under cover and off the ground (to avoid contact with ground moisture).

DriTherm® Cavity Slabs should not be left permanently exposed to the elements.

The product must be protected from prolonged exposure to sunlight, and stored dry and flat.



✗ Slabs exposed to the elements

HANDLING

DriTherm® Cavity Slabs are light and easy to handle; care should be exercised to avoid crushing the edges or corners. If damaged, the product should be discarded.

Damaged, contaminated or wet product must not be used.

It is recommended that dust masks, gloves and long-sleeved clothing should be worn during cutting and handling of the product.

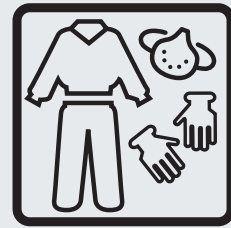

During construction exposed areas of slabs should always be covered at the end of a day's work or in heavy rain.

Polyethylene covers should be used to provide protection and prevent work from becoming saturated.

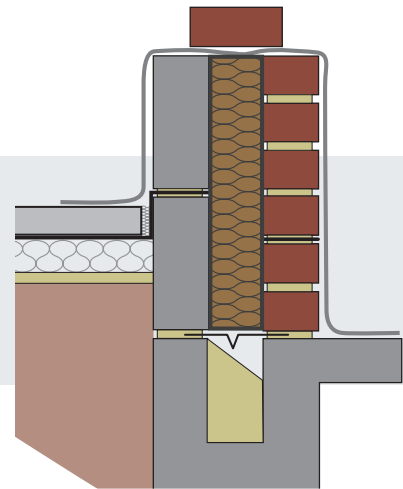

INSTALLATION SEQUENCE

STEP 1

Build up the first stage of one leaf of masonry to include the first row of ties above the commencement of DriTherm® Cavity Slabs.

Clean mortar spots from any ties or cavity tray.

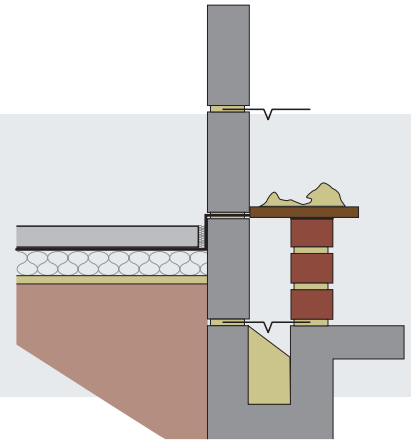

STEP 2

Position the DriTherm® Cavity Slab against the masonry leaf. They should be cut to course if necessary and should be taken below the floor insulation to reduce thermal bridging, with no risk of capillary action. DriTherm® Cavity Slabs do not wick moisture and are suitable for use below DPC. Always ensure that DriTherm® Cavity Slabs course with wall ties.

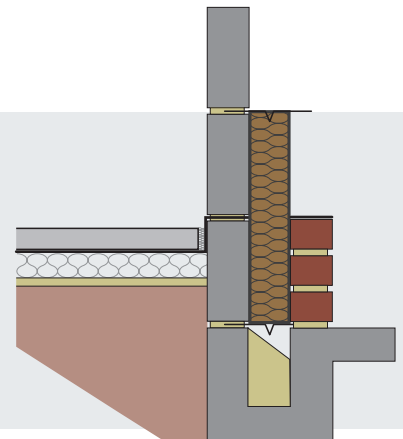

STEP 3

The following leaf is then built to the top level of the DriTherm® Cavity Slabs. Do not let the second leaf overtake so as to create a trough (See step 5 regarding choice of leading leaf)

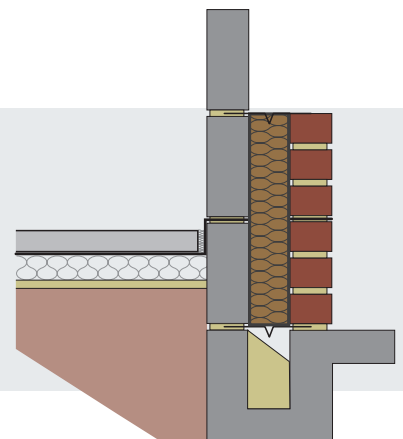

INSTALLATION SEQUENCE

STEP 4

Proceed similarly with successive stages of the wall. As with normal masonry cavity wall constructions, no mortar should remain in the cavity, particular care should be taken to keep batt joints closely butted and free from mortar. To facilitate keeping the top edges of batts clean it is recommended that cavity boards be used.

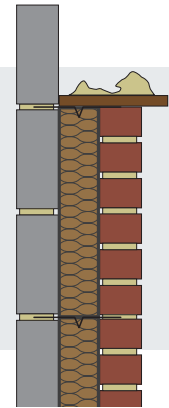

STEP 5

Building may proceed leading with either the inner or the outer leaf. When leading with the inner leaf it is recommended to build a trough no more than one brick deep at horizontal joints of DriTherm® Cavity Slabs. The mortar joints should be struck flush inside the cavity and any mortar droppings must be cleaned of before the next batt is fitted.

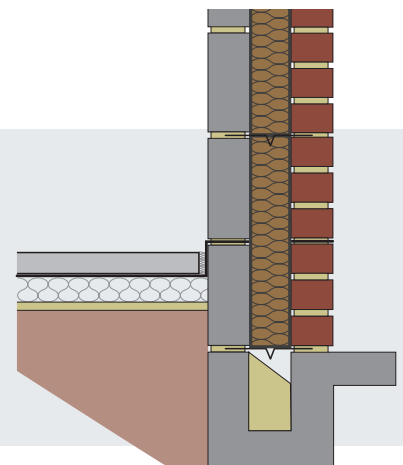

The illustrations outline technique only, and do not imply that the outer leaf must be built first.

Construction practice will vary from site to site. Where design details differ from those illustrated, please contact Knauf Insulation Technical Support Team for any clarification.

INSTALLATION

The construction of all masonry cavity walls should be satisfactory to comply with the Building Regulations and warranty body technical standards where applicable.

All external walls are to be insulated during construction by completely filling the cavity with DriTherm® Cavity Slabs.

Cavities should be designed to suit the thickness of the proposed insulation material. Thicker slabs should not be compressed into narrow cavities.

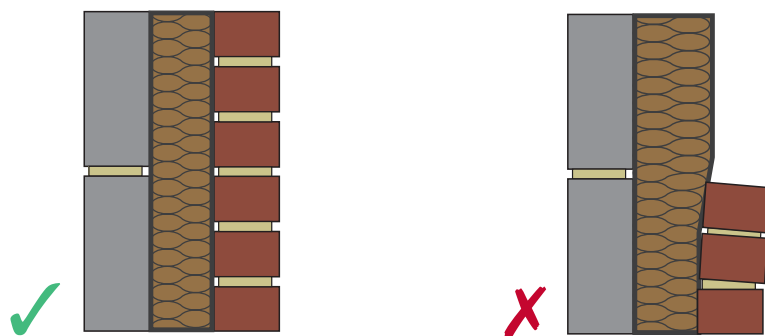

In fully filled applications, the type of insulation, its thickness and the wall construction should be suitable for the exposure of the building. (See Page 19).

Excess mortar must be cleaned off as shown; a cavity or board will protect the installed slabs and keep the cavity clear.

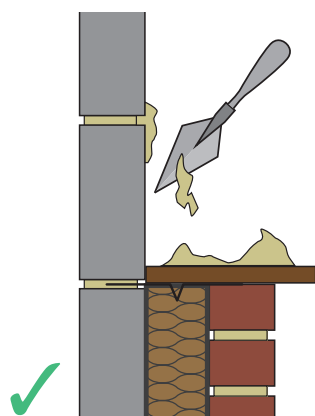

INSTALLATION

Workmanship should be maintained to minimise the risk of damp penetration to the inside of the home. Gaps compromise thermal performance, provide routes for dampness, and condensation can form on the cold spots where insulation is missing. Insulation should be close butted with no gaps.

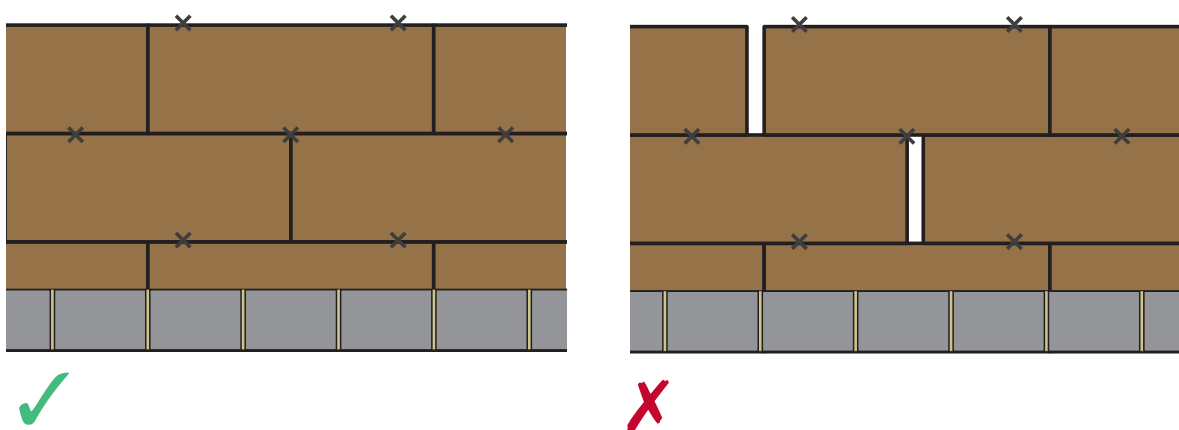

Any cutting and fitting should be neatly done, so not to distort the layers of glass wool which could compromise the material's performance.

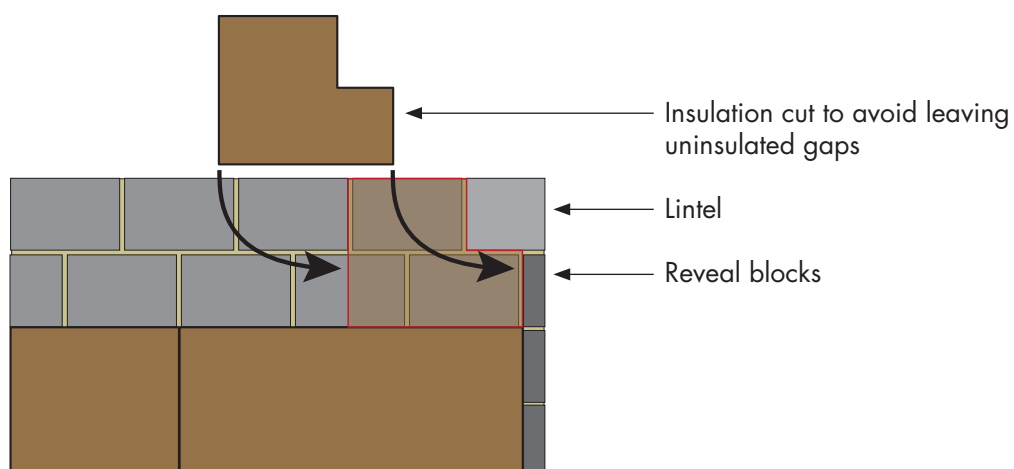

INSTALLATION

It is essential that walls are designed and constructed to incorporate the precautions given in the BBA Certificate 95/3212 to prevent moisture penetration.

The quality of walls should be constructed in accordance with BS 8000-3:2020 code of practice for masonry workmanship. Workmanship should be maintained to minimize the risk of damp penetration to the inside of the home.

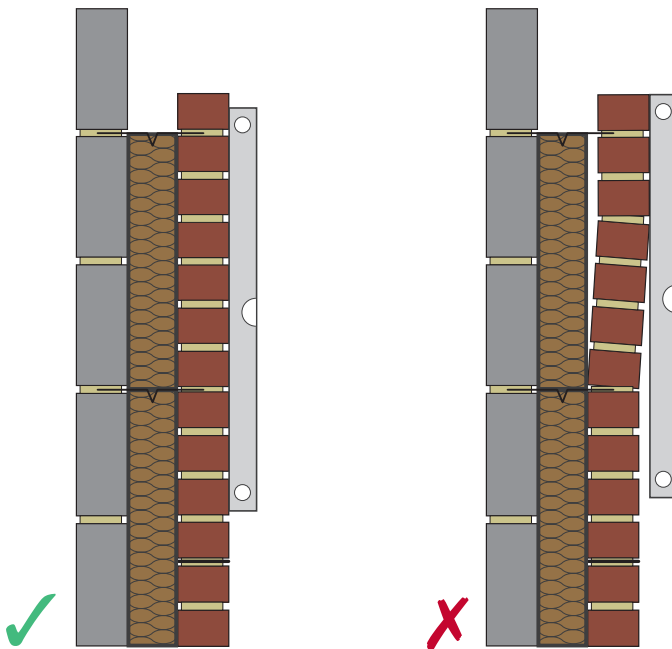

Knauf Insulation and NHBC recommend a cavity of uniform thickness is maintained throughout the construction and therefore we do not recommend rough stone to be used. Where natural stone is specified, we recommend the stone is cut to face to ensure the resultant cavity is uniform and parallel and stone is in accordance with this recommendation or alternatively a backing block is used in the outer leaf.

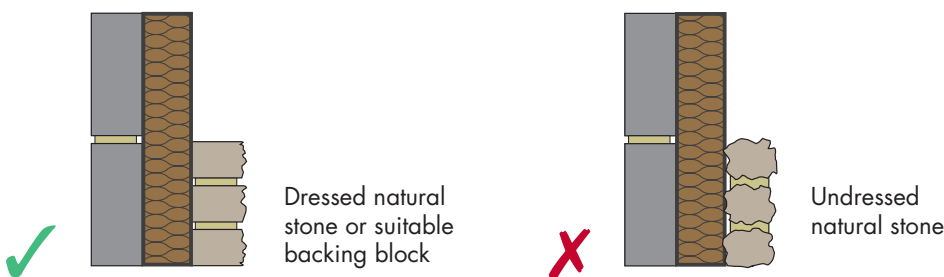

INSTALLATION

When insulating wide cavities with two layers of DriTherm® Cavity Slabs, the placement remains the same, but the vertical joints in the second layer must not be coincidental with the vertical joints in the first layer.

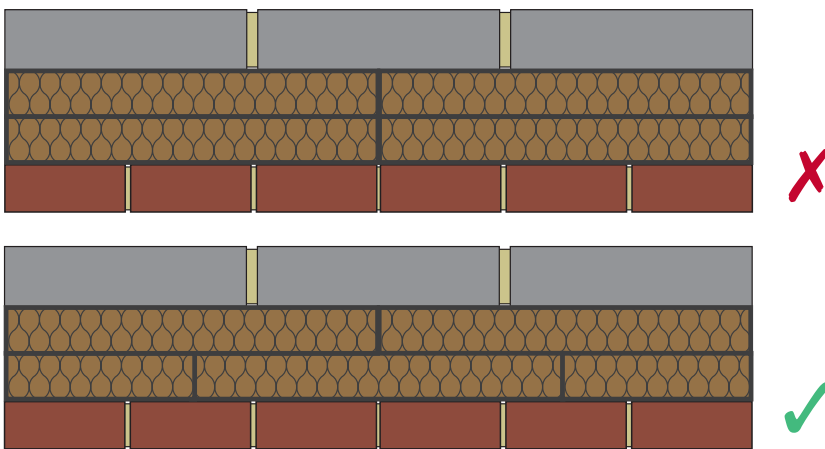

It is recommended that mineral wool batts with a thickness of 75mm or less are bent around corners to ensure that no gaps are left between batts, into which mortar could fall. Otherwise ensure joints are closely butted.

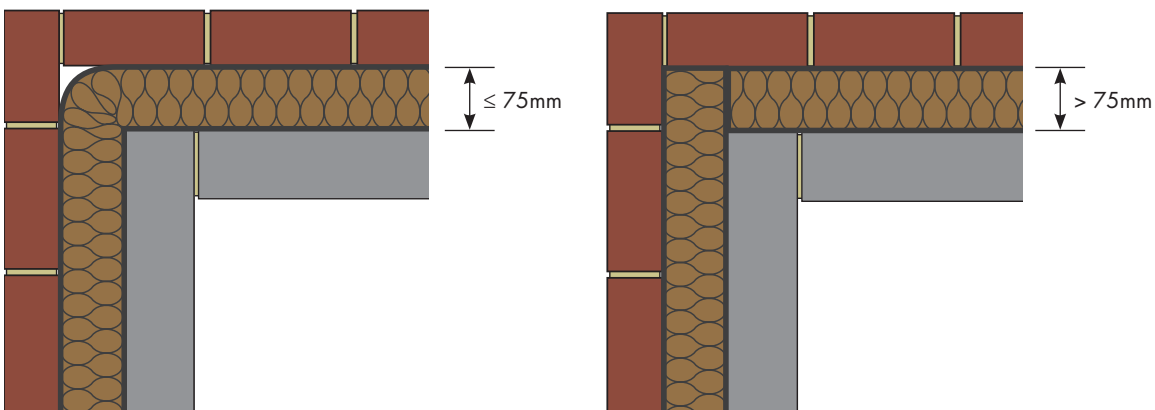

CUTTING

CUT NEATLY WITH A SHARP INSULATION SAW/KNIFE

Slabs can be easily cut with a sharp knife or fine toothed saw to fit features such as windows, doors and apertures.

? Gives a factory quality cut and prevents tearing

✓ Use insulation saw or knife ✗ Cut using bladed saw



Above, below and beside openings, where cut strips of DriTherm® Cavity Slabs may be needed, particular care should be taken to fit closely and ensure work is clean and free from debris.

It is essential that cut pieces completely fill the spaces for which they are intended and no gaps are left in the insulation.

Small pieces must be fitted with the fibre layer parallel to the plane of the wall.

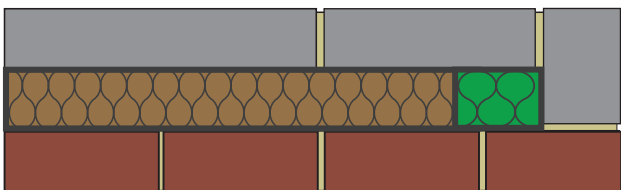
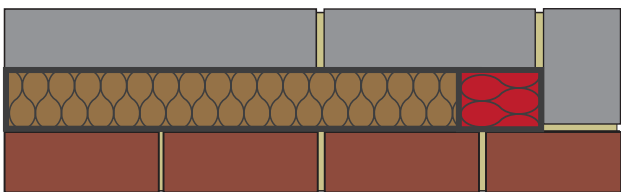

WALL TIES

The leaves of a cavity wall should be tied together by wall ties of a type that are suitable for the type of construction.

The wall ties should be either embedded in the horizontal mortar joints at the time the units are laid or fixed in accordance with the manufacturer's instructions.

DriTherm® Cavity Slabs are supplied in 1200 x 455mm batts for use between wall ties at 450mm vertical centres.



Standard stainless steel wall ties are suitable with a positive drip which will penetrate the top edge of the cavity slab halfway across its width.

The use of any other type of tie should be referred to manufacturer to understand the suitability and maximum cavity width for which the use of a specific tie is approved.



WALL TIES

Generally, rows of wall ties should be at 450mm vertical spacing and at horizontal spacings of no more than 900mm or as otherwise required by the structure. Where whole rows of ties are at different vertical spacings DriTherm® Cavity Slabs should be cut to course, allowing an extra 5mm for compression to form close butt joints.

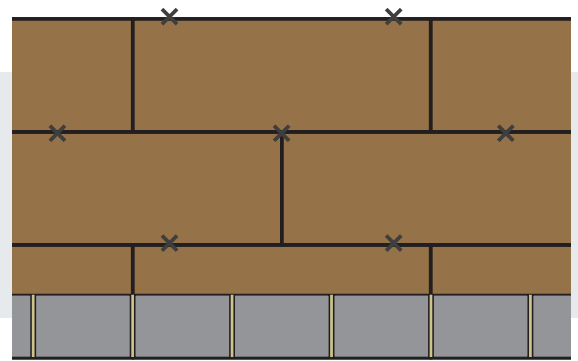

Where cavity insulation batts or slabs start below DPC level, the vertical and horizontal spacing of wall ties should be compatible with the spacing to be used above DPC level.

The first course of insulation batts should be fully supported, either on wall ties at approximately 600mm horizontal spacings (at a level to be decided by the specifier), on the weak concrete at the foot of the cavity, or on a cavity tray. Subsequent runs of wall ties to be at no more than 900mm centres horizontally, or as otherwise required by the structure, and at 450mm vertically.

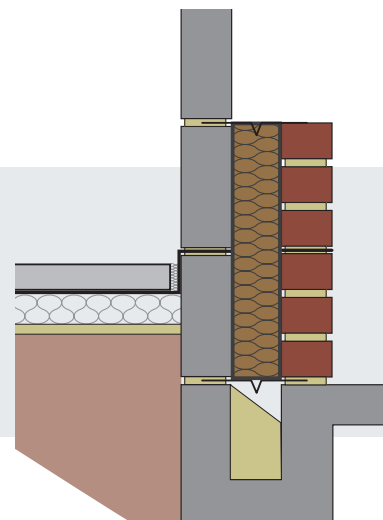

DriTherm® Cavity Slabs can be used in situations where they bridge the DPC in walls. Tests by the British Board of Agrément confirm that DriTherm® Cavity Slabs will not transmit water to the inner leaf, nor will they transmit moisture by capillary action across the cavity or from below damp proof course level provided they are installed correctly.

DriTherm® Cavity Slabs do not add to the risk of water penetration.

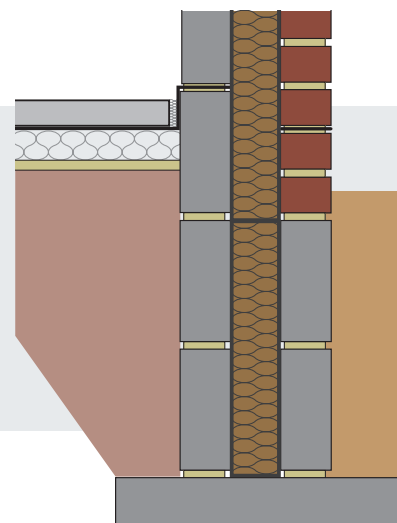

WALL TIES

Wall ties should be built into joints, not pushed and positioned, so that the drip faces downwards and the ties are level or slope slightly towards the outer leaf.

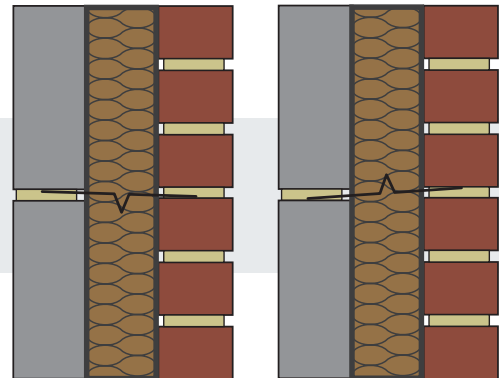

Where extra ties are required, e.g. at the side of openings, DriTherm® Cavity Slabs should be cut and fitted carefully around them. When off-cuts of DriTherm® Cavity Slab are needed, the batts can be cut with a long bladed knife or fine tooth saw.

Mortar droppings should be removed from wall ties and the edges of the insulation prior to the next row of slabs being installed.

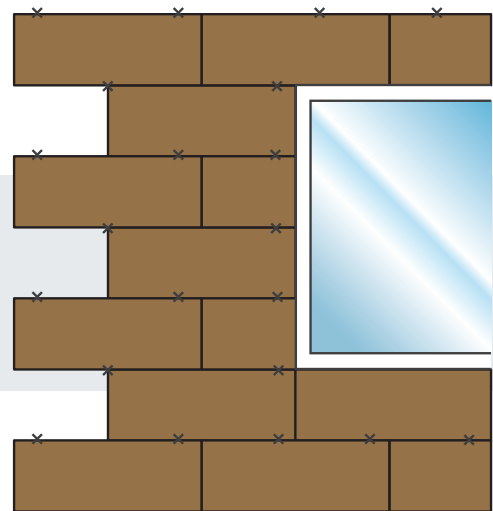

Wall ties of the correct type should be installed where required, and be suitable for their intended use and location.

CAVITY TRAYS

Cavity trays and lintels should be installed to ensure that penetrating water is directed only to the outer leaf.

Cavity trays should be provided:

- At all interruptions of the cavity such as lintels and sleeved vents and ducts
- Above insulation that stops short of the top of the wall.

Cavity trays should rise at least 140mm within the cavity, be self-supporting or fully supported with joints lapped and sealed.

Stop ends should be provided to the ends of all cavity trays.

Weepholes should be provided at no more than 900mm centres to drain each cavity tray, with at least two weepholes per cavity tray.

If DriTherm® Cavity Slabs are terminated vertically at an open cavity, a vertical DPC must be fitted up the inside face of the outer leaf to ensure that any mortar droppings on exposed edges do not bridge the cavity.

In buildings where the roof insulation is at ceiling level, the cavity insulation may be terminated 200mm above the loft insulation. It should be protected by a cavity tray, to avoid the top edge being bridged by mortar dropping from above. Similarly, if insulation starts at high level and terminates part way down the walls, it should be protected on the underside by a cavity tray.

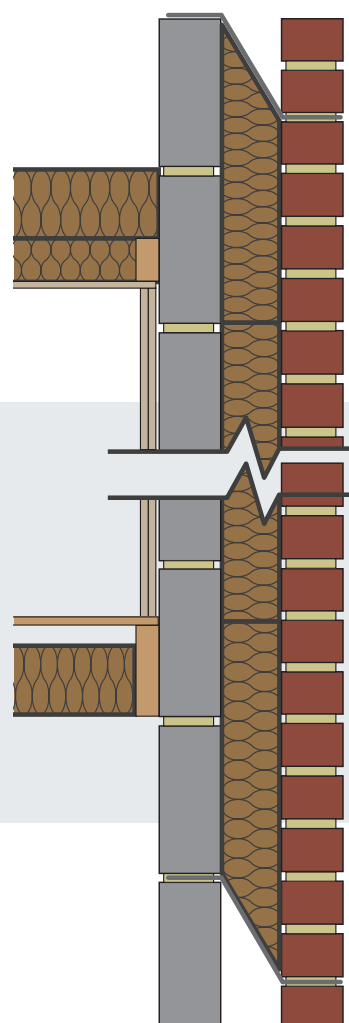
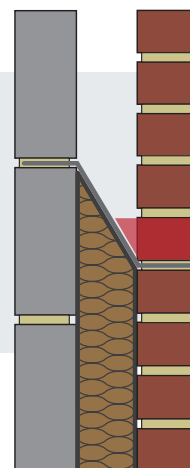

CAVITY TRAYS

Where the cavity has full-fill insulation, a cavity tray should be used above the highest insulation level, unless the insulation is taken to the top of the wall, for example to the ridge level on gable walls as shown below.

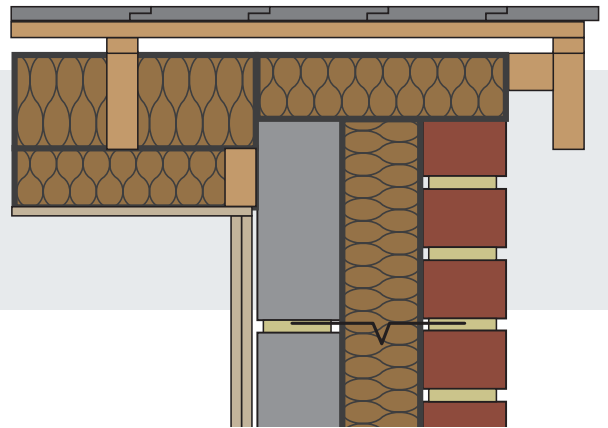
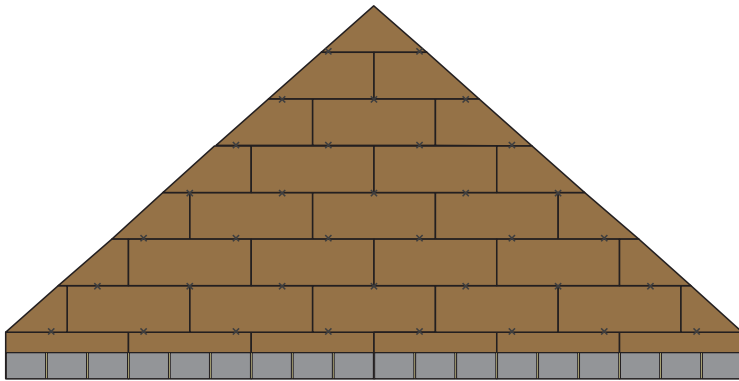

Cavity trays should remain clear of droppings and debris. DriTherm® Cavity Slabs can be easily cut to a chamfer to suit the profile of the cavity tray and ensure no voids are present in the cavity. Slabs can be easily cut with a sharp knife or saw to suit.

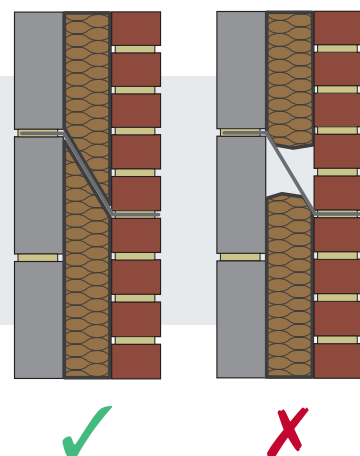

PROBLEMS TO AVOID

Do not push batts into the cavity. Mortar snots may be dislodged and bridge the cavity. This can happen all too easily where a change in the leading leaf occurs and care should be exercised at such positions to ensure correct application.

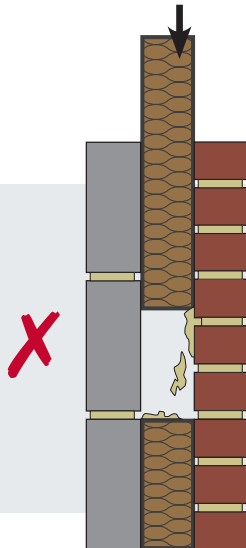

Do not position DriTherm® Cavity Slabs on batts that have not been cleaned of mortar droppings.

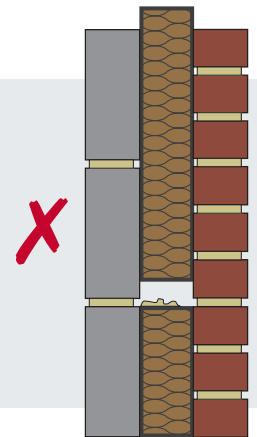

Do not tear or impale DriTherm® Cavity Slabs. If there are protrusions into the cavity, DriTherm® Cavity Slab should be carefully cut to fit, particularly where there are extra wall ties around openings.

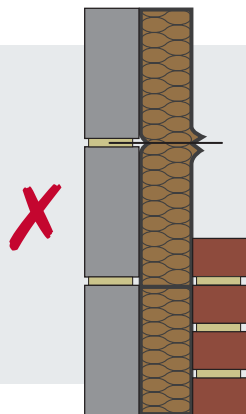

When using small off-cuts, the face of the batts and not the edge, shall be positioned against the wall surface.

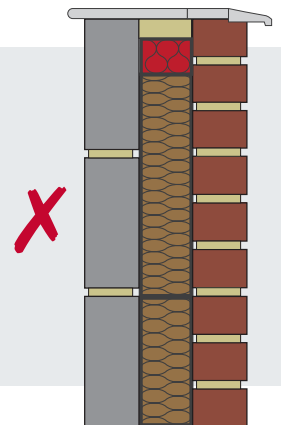

DETAILING REQUIREMENTS

As with gable ends, cavity insulation should be taken to the top of parapet walls. In taller parapets, DPC trays should fall to the outer leaf.

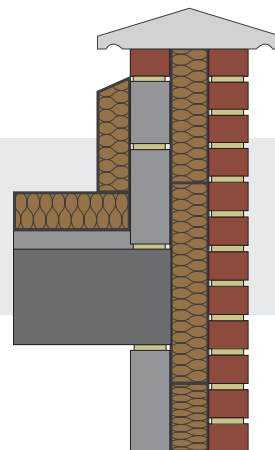

At eaves, cavity insulation should terminate at the top of the wall to meet the insulation at ceiling level. This ensures continuity between the wall and roof insulation and prevents any unwanted heat loss at the junction.

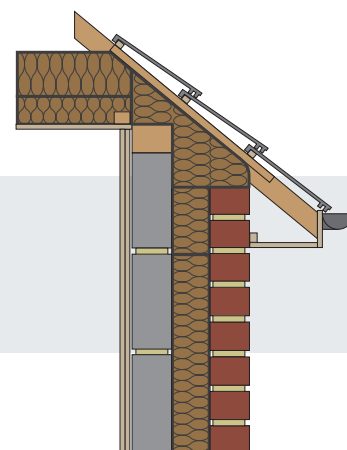

Where the product is installed in a curved wall application the minimum permissible internal radius should be no less than 1750mm.

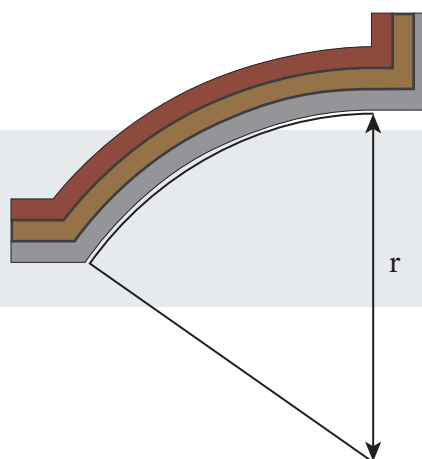

EXPOSURE ZONES

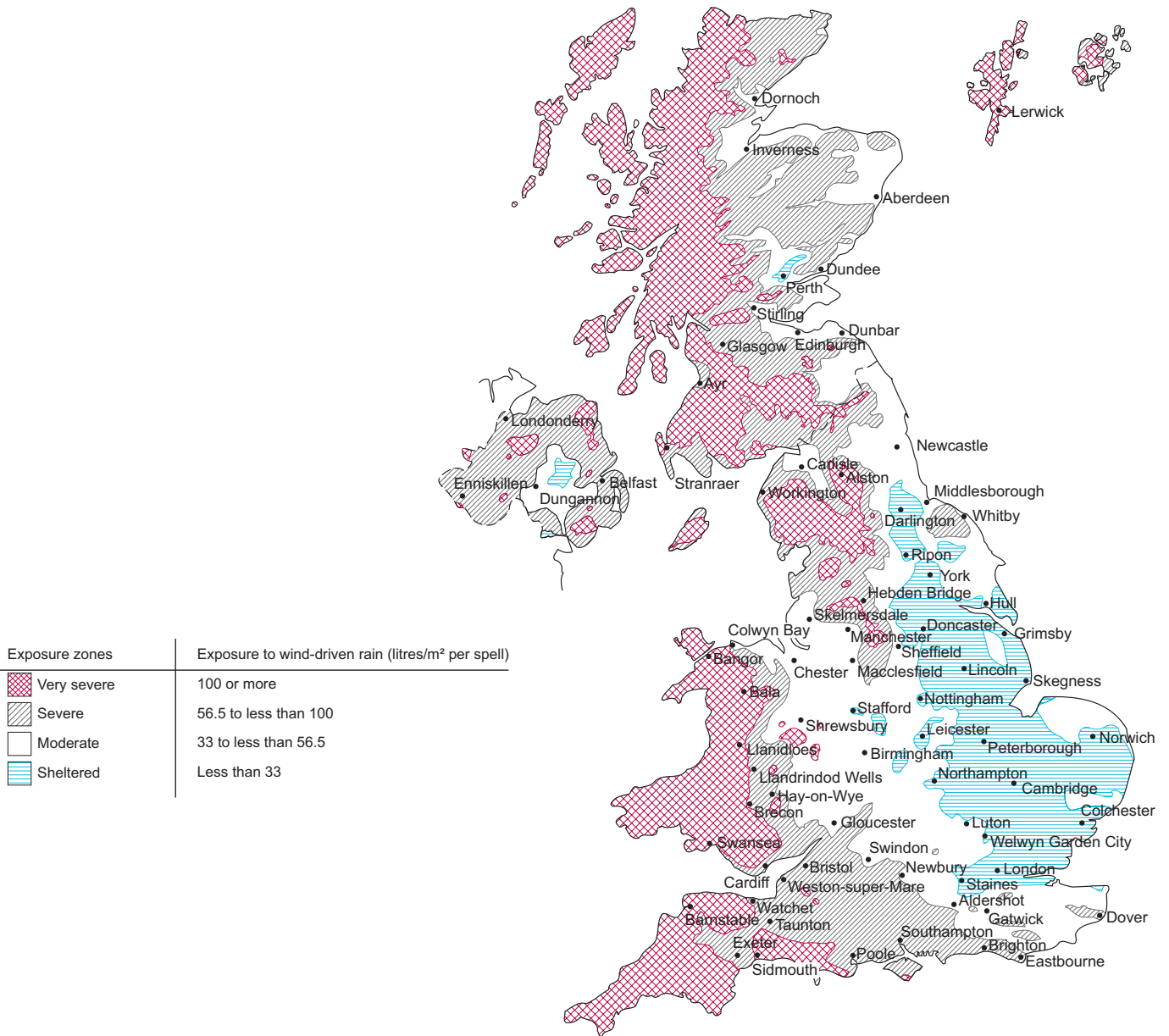

External leaf construction	Exposure Zone			
	Sheltered	Moderate	Severe	Very Severe
Impervious cladding	✓	✓	✓	✓
Fairfaced masonry with impervious cladding to all walls above ground storey	✓	✓	✓	✓
Fully rendered	✓	✓	✓	✓
Fairfaced masonry	✓	✓	✓	✗

Where there is concern as to a site's localised elevation and/or exposure, Knauf Insulation is willing to undertake a site specific Wind Driven Rain calculation. Please call our Technical Support Team on 01744 766 666 or e-mail technical.uk@knaufinsulation.com. For further information on exposure zones and suitable external wall finishes please see [Approved Document C](#).

CONTACTS

Customer Service (sales)

Tel: 0844 800 0135
email: sales.uk@knaufinsulation.com

Technical Support Team

Tel: 01744 766 666
email: technical.uk@knaufinsulation.com



Knauf Insulation Ltd PO Box 10, Stafford Road, St.Helens, Merseyside, WA10 3NS. UK

For more information please visit knaufinsulation.co.uk

All rights reserved, including those of photomechanical reproduction and storage in electronic media. Extreme caution was observed when putting together and processing the information, texts and illustrations in this document. Nevertheless, errors cannot quite be ruled out. The publisher and editors cannot assume legal responsibility or any liability whatever for incorrect information and the consequences thereof. The publisher and editors will be grateful for improvement suggestions and details of possible errors pointed out.

challenge.
create.
care.